



BLACK SERIES



TERMOFOC is a company who specialises in the design and manufacturing of renewable energy based heating solutions such as wood burning insert and freestanding stoves.

In our constant pursuit for innovation we have developed a new range of inserts and stoves that combine a modern design with high efficiency level. Our new equipment will allow you to produce more heat from your wood whilst releasing less CO2 to the environment making them environmental friendly.

Our new range has been named "Black Series" a combination of efficiency and design meant to take the flame experience to the next level.

TERMOFOC conçoit et fabrique des foyers de chaleur et des poêles à biomasse, alliant efficacité et design dans une recherche permanente de l'innovation.

C'est pourquoi nous avons créé une nouvelle ligne de foyers et de poêles techniquement conçus pour consommer moins de bois et produire plus de chaleur avec moins d'émissions de CO2, devenant ainsi plus respectueux de l'environnement.

Cette évolution technique demandait une image adaptée "Black Series", présentant des foyers et des poêles conçus avec le design parfait pour vous faire apprécier le plaisir de la flamme.





OVERVIEW
INFORMATIONS GÉNÉRALES



LISBOA 700 EA



LISBOA 800 EA



LISBOA 900 EA



LISBOA 900 DF EA



FARO 500 EA



FARO 600 EA



FARO 700 EA



FARO 800 EA



FARO 900 EA



FARO 600 DF EA



FARO 900 DF EA



LISBOA SL 700 EA



LISBOA SL 800 EA



LISBOA SL 900 EA



FARO SL 500 EA



FARO SL 600 EA



FARO SL 700 EA



FARO SL 800 EA



FARO SL 900 EA



TECHNICAL DETAILS DÉTAILS TECHNIQUES

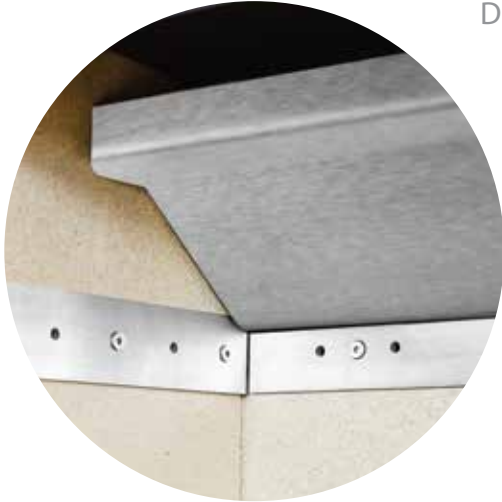

DUAL COMBUSTION AIR OUTLET FOR A BETTER CONTROL OF THE FLAME
SORTIE D'AIR POUR DOUBLE COMBUSTION, ASSURANT UN CONTRÔLE DE FLAMME PLUS EFFICACE



STAINLESS STEEL HANDLE
POIGNÉE INOX



STAINLESS STEEL FINISH INSIDE THE DOOR
INTÉRIEUR DE PORTE AVEC FINITION EN INOX



AIR OUTLETS HELPING TO MAINTAIN CLEAN GLASS
SORTIES D'AIR POUR SYSTÈME « VITRE PROPRE »



SWITCH FOR TURNING THE FAN ON/OFF
INTERRUPTEUR DE VENTILATION
PERMETTANT D'ÉTEINDRE LES VENTILATEURS



EXTERNAL AIR INTAKE FOR BETTER EFFICIENCY AND BETTER AIR QUALITY INSIDE THE BUILDING
ARRIVÉE D'AIR EXTÉRIEUR POUR LA COMBUSTION.
QUALITÉ DE L'AIR TOUJOURS GARANTIE DANS VOTRE LOGEMENT



LISBOA 700 EA

This stove has a sleek and refined design finished with chromed details in the door and handle. BLACK SERIES stoves provide a wide view of the flame whilst keeping a low fuel consumption assuring good levels of efficiency. The triple combustion system provides a perfectly controlled flame while the silent dual speed fans can be controlled to regulate the hot air outtake. As with all BLACK SERIES stoves it has an outdoor air intake which will improve the efficiency of the combustion, the quality of the air inside the building and will avoid technical malfunctions due to fluctuations in air pressure.

Équipements au design moderne et épuré, avec portes et poignées à finition spéciale en acier inoxydable. Les foyers BLACK SERIES offrent une ample vision du feu, tout en garantissant une faible consommation de bois et un rendement élevé. La triple combustion assure une flamme parfaite et contrôlée. Leurs ventilateurs tangentiels à haute performance sont silencieux et à deux vitesses, pour améliorer votre confort. La qualité de l'air de votre logement bénéficiera de l'arrivée d'air extérieur directe, évitant ainsi les problèmes de fonctionnement par dépression.

CHARACTERISTICS: CARACTÉRISTIQUES:	LISBOA 700 EA	LISBOA 800 EA	LISBOA 900 EA
Fuel Combustible	Wood Bois	Wood Bois	Wood Bois
Output Débit	9 a 12 kw	10 a 13 kw	10 a 14 kw
Efficiency Efficacité	82%	82%	81%
Consumption Consommation	2.8 kg	2.9 kg	3.2 kg
Recommended Load Charge Recommandée	2.6 kg	2.9 kg	3.2 kg
Fan Ventilateur	Man./Auto. 2 speeds Man./Auto. 2 vitesses	Man./Auto. 2 speeds Man./Auto. 2 vitesses	Man./Auto. 2 speeds Man./Auto. 2 vitesses
Weight Poids	97 kg	107 kg	117 kg
Volume Heating Chauffage de Volume	324 m ³	337 m ³	363 m ³
Dimensions Dimensions	690 x 548 x 350 mm	790 x 548 x 350 mm	890 x 548 x 350 mm

ENERGY CLASS CLASSE ÉNERGÉTIQUE

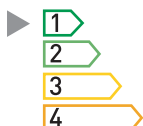





LISBOA 900 DF EA

Perfect for installing as a separation between two ambiances or rooms this double sided stove is not only a heating solution but also an outstanding ornamental piece. This stove combines a classic and timeless design with the latest developments in efficiency. A triple combustion system will ensure a perfect and controlled combustion and a beautiful wavy flame. The high performance fans are silent and dual speed for increased comfort. As with all BLACK SERIES stoves it has an outdoor air intake which will improve the efficiency of the combustion, the quality of the air inside the building and will avoid technical malfunctions due to fluctuations in air pressure.

Ce modèle se distingue par sa double face permettant de chauffer deux pièces en même temps. Équipements au design moderne et épuré, avec portes et poignées à finition spéciale en acier inoxydable. Les foyers BLACK SERIES offrent une ample vision du feu, tout en garantissant une faible consommation de bois et un rendement élevé. La triple combustion assure une flamme parfaite et contrôlée. Leurs ventilateurs tangentiels à haute performance sont silencieux et à deux vitesses, pour améliorer votre confort. La qualité de l'air de votre logement bénéficiera de l'arrivée d'air extérieur directe, évitant ainsi les problèmes de fonctionnement par dépression.

CHARACTERISTICS: LISBOA 900 DF EA CHARACTÉRISTIQUES:

Fuel Combustible	Wood Bois
Output Débit	10 a 14 kw
Efficiency Efficacité	80 %
Consumption Consommation	3.4 kg
Recommended Load Charge Recommandée	3.2 kg
Fan Ventilateur	Man./Auto. 2 speeds Man./Auto. 2 vitesses
Weight Poids	142 kg
Volume Heating Chauffage de Volume	351 m ³
Dimensions Dimensions	890 x 548 x 430 mm

ENERGY CLASS CLASSE ÉNERGÉTIQUE

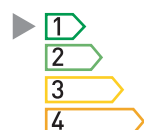





FARO 800 EA

This stove combines a classic and timeless design with the latest developments in efficiency. A triple combustion system will ensure a perfect and controlled combustion and a beautiful wavy flame. The high performance fans are silent and dual speed for increased comfort. As with all BLACK SERIES stoves it has an outdoor air intake which will improve the efficiency of the combustion, the quality of the air inside the building and will avoid technical malfunctions due to fluctuations in air pressure.

Equipement au design classique et toutefois intemporel, pourvu d'une technologie de haut rendement. Son système de triple combustion assure une combustion parfaite et contrôlée, ainsi que de belles flammes. Nous utilisons des ventilateurs tangentiels à haute performance, silencieux et à deux vitesses de ventilation pour améliorer votre confort. Les foyers BLACK SERIES ont une entrée d'air extérieur pour une combustion dont la qualité de l'air de votre logement bénéficiera tout en évitant les problèmes de fonctionnement par dépression.

CHARACTERISTICS: CARACTÉRISTIQUES:	FARO 500 EA	FARO 600 EA	FARO 700 EA	FARO 800 EA	FARO 900 EA
Fuel Combustible	Wood Bois	Wood Bois	Wood Bois	Wood Bois	Wood Bois
Output Débit	6 a 9 kw	7 a 10 kw	9 a 12 kw	10 a 13 kw	10 a 14 kw
Efficiency Efficacité	82%	82%	82%	82%	81%
Consumption Consommation	2.5 kg	2.7 kg	2.8 kg	2.9 kg	3.2 kg
Recommended Load Charge Recommandée	2.4 kg	2.5 kg	2.6 kg	2.9 kg	3.2 kg
Fan Ventilateur	Man./Auto. 2 speeds Man./Auto. 2 vitesses	Man./Auto. 2 speeds Man./Auto. 2 vitesses	Man./Auto. 2 speeds Man./Auto. 2 vitesses	Man./Auto. 2 speeds Man./Auto. 2 vitesses	Man./Auto. 2 speeds Man./Auto. 2 vitesses
Weight Poids	78 kg	89 kg	96 kg	106 kg	116 kg
Volume Heating Chauffage de Volume	294 m ³	312 m ³	324 m ³	337 m ³	363 m ³
Dimensions Dimensions	500 x 548 x 350 mm	600 x 548 x 350 mm	690 x 548 x 350 mm	790 x 548 x 350 mm	890 x 548 x 350 mm

ENERGY CLASS CLASSE ÉNERGÉTIQUE

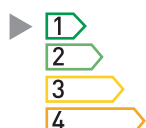





FARO 900 DF EA

Perfect for installing as a separation between two ambiances or rooms this double sided stove is not only a heating solution but also an outstanding ornamental piece. This stove combines a classic and timeless design with the latest developments in efficiency. A triple combustion system will ensure a perfect and controlled combustion and a beautiful wavy flame. The high performance fans are silent and dual speed for increased comfort. As with all BLACK SERIES stoves it has an outdoor air intake which will improve the efficiency of the combustion, the quality of the air inside the building and will avoid technical malfunctions due to fluctuations in air pressure.

Equipped with classic and timeless design, provided with a high performance technology. Its triple combustion system ensures a perfect and controlled combustion, as well as beautiful flames. We use high performance, silent and dual speed fans to improve your comfort. BLACK SERIES stoves have an outdoor air intake for a combustion that the quality of the air in your home will benefit from, avoiding problems of operation by depression.

CHARACTERISTICS: CARACTÉRISTIQUES:	FARO 600 DF EA	FARO 900 DF EA
Fuel Combustible	Wood Bois	Wood Bois
Output Débit	7 a 10 kw	10 a 14 KW
Efficiency Efficacité	80 %	80 %
Consumption Consommation	2.9 kg	3.4 kg
Recommended Load Charge Recommandée	2.9 kg	3.2 kg
Fan Ventilateur	Man./Auto. 2 speeds Man./Auto. 2 vitesses	Man./Auto. 2 speeds Man./Auto. 2 vitesses
Weight Poids	105 kg	141 kg
Volume Heating Chauffage de Volume	295 m ³	351 m ³
Dimensions Dimensions	600 x 548 x 430 mm	890 x 548 x 430 mm

ENERGY CLASS CLASSE ÉNERGÉTIQUE

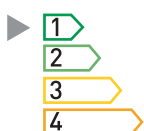





LISBOA SL 800 EA

Our freestanding stoves are not just a heating solution. We put our best efforts in designing our freestanding stoves knowing that while they would require all the best operating features they would also need to be a decorative piece that would fit and enrich the environment in which it is installed. So we have developed this BLACK SERIES stove featured with high standard features within a clean and sleek design piece.

Par-delà leur dimension fonctionnelle, nos poêles assurant un chauffage efficace de l'intérieur où ils s'insèrent, ces équipements sont un élément de la décoration. Nous avons pour cela attaché une attention toute particulière au design, permettant ainsi d'enrichir visuellement les intérieurs. Ce modèle BLACK SERIES présente des lignes à tendance minimaliste et « clean », traduisant l'efficacité de son rendement en une image de classe et de sophistication.

CHARACTERISTICS: CARACTÉRISTIQUES:	LISBOA SL 700 EA	LISBOA SL 800 EA	LISBOA SL 900 EA
Fuel Combustible	Wood Bois	Wood Bois	Wood Bois
Output Débit	9 a 12 kw	10 a 13 kw	10 a 14 kw
Efficiency Efficacité	82 %	82 %	81%
Consumption Consommation	2.8 kg	2.9 kg	3.2 kg
Recommended Load Charge Recommandée	2.6 kg	2.9 kg	3.2 kg
Fan Ventilateur	Man./Auto. 2 speeds Man./Auto. 2 vitesses	Man./Auto. 2 speeds Man./Auto. 2 vitesses	Man./Auto. 2 speeds Man./Auto. 2 vitesses
Weight Poids	181 kg	203 kg	225 kg
Volume Heating Chauffage de Volume	324 m ³	337 m ³	363 m ³
Dimensions Dimensions	790 x 960 x 430 mm	890 x 960 x 430 mm	990 x 960 x 430 mm

ENERGY CLASS CLASSE ÉNERGÉTIQUE

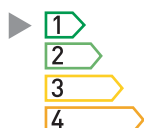





FARO SL 500 EA

Not just a heating solution but also a decorative piece. This new BLACK SERIES freestanding stove will gather the efficiency of a heating and ventilation system with a new sleek and timeless design resulting in an atmosphere of comfort and well-being.

À l'image de nos foyers, nos poêles visent également à chauffer les intérieurs tout en les décorant. Ce nouveau poêle BLACK SERIES combine l'efficacité d'un système de ventilation et de chauffage à un nouveau design classique et élégant, créant une atmosphère de confort et bien-être.

CHARACTERISTICS: CARACTÉRISTIQUES:	FARO SL 500 EA	FARO SL 600 EA	FARO SL 700 EA	FARO SL 800 EA	FARO SL 900 EA
Fuel Combustible	Wood Bois	Wood Bois	Wood Bois	Wood Bois	Wood Bois
Output Débit	6 a 9 kw	7 a 10 kw	9 a 12 kw	10 a 13 kw	10 a 14 kw
Efficiency Efficacité	82 %	82 %	82 %	82 %	81 %
Consumption Consommation	2.5 kg	2.7 kg	2.8 kg	2.9 kg	3.2 kg
Recommended Load Charge Recommandée	2.4 kg	2.5 kg	2.6 kg	2.9 kg	3.2 kg
Fan Ventilateur	Man./Auto. 2 speeds Man./Auto. 2 vitesses	Man./Auto. 2 speeds Man./Auto. 2 vitesses	Man./Auto. 2 speeds Man./Auto. 2 vitesses	Man./Auto. 2 speeds Man./Auto. 2 vitesses	Man./Auto. 2 speeds Man./Auto. 2 vitesses
Weight Poids	136 kg	163 kg	180 kg	202 kg	224 kg
Volume Heating Chauffage de Volume	294 m ³	312 m ³	324 m ³	337 m ³	363 m ³
Dimensions Dimensions	590 x 960 x 430 mm	690 x 960 x 430 mm	790 x 960 x 430 mm	890 x 960 x 430 mm	990 x 960 x 430 mm

ENERGY CLASS CLASSE ÉNERGÉTIQUE

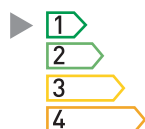





FREESTANDING STOVES POÊLES



FINISHING FINIS



FINISHING IN STONE, CORTEN AND GLASS FINIS EN PIERRE, CORTEN ET VERRE



DETAILED VIEW DETALHADA
DÉTAIL

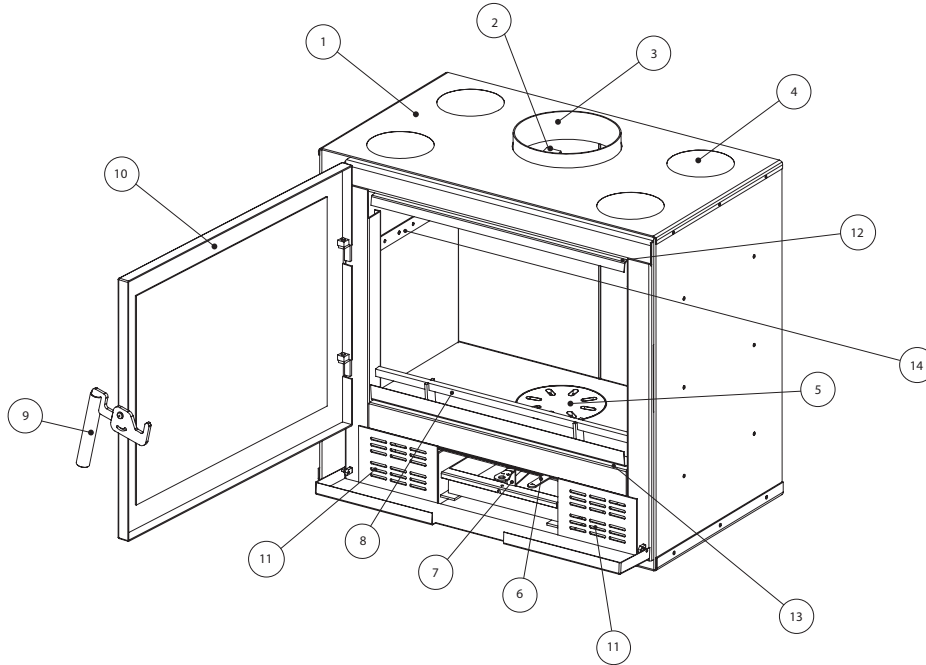

1. CASE
1. CARTER

2. BAFFLES
2. DÉFLECTEUR

3. GAS OUTLET
3. SORTIE DE GAZ

4. ADDITIONAL HOT AIR OUTLET
4. SORTIE SUPPLÉMENTAIRE D'AIR

5. ASH GRATE
5. GRILLE À CENDRES

6. AIRWASH
6. AIRWASH

7. PRIMARY AIR
7. AIR PRIMAIRE

8. FIREWOOD RETAINER
8. BOIS DE RETENUE

9. DOOR OPENING LATCH
9. OUVERTURE DE LA PORTE

10. DOOR
10. PORTE

11. FANS
11. VENTILATEURS

12. 13. CLEAN GLASS
12. 13. CLEAN GLASS

14. TRIPLE COMBUSTION
14. COMBUSTION TRIPLE

STOVES TECHNICAL INFORMATION

FOYEURS INFORMATION TECHNIQUE

LISBOA 700 EA

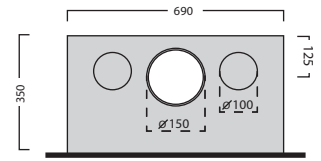
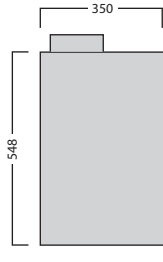
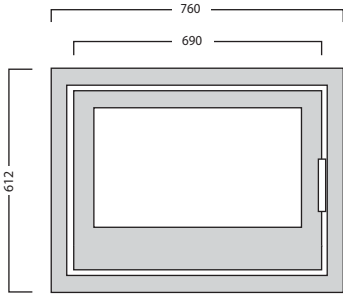

LISBOA 800 EA

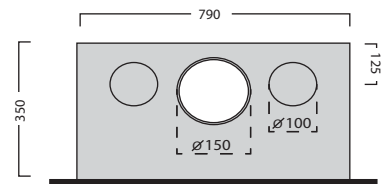
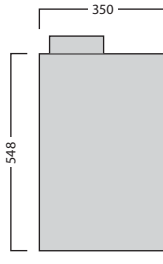
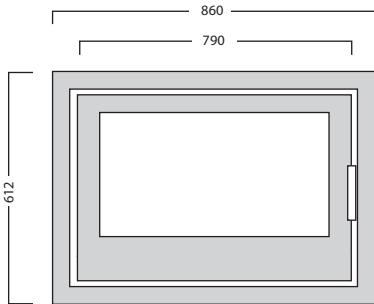

LISBOA 900 EA

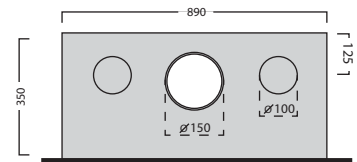
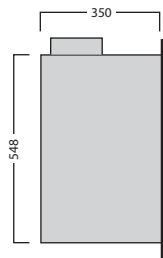
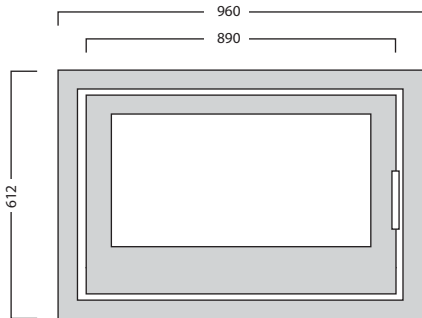

LISBOA 900 DF

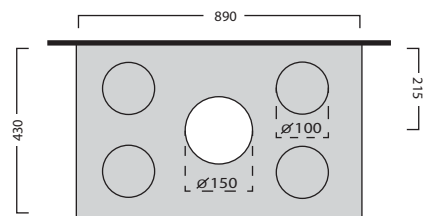
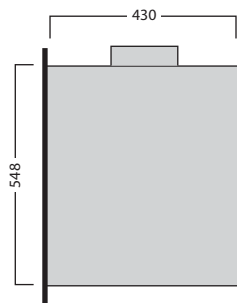
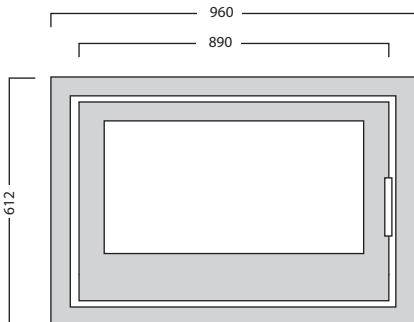

FARO 500 EA

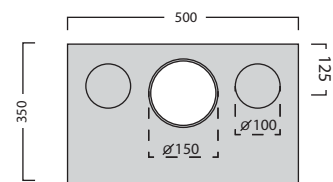
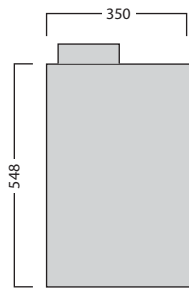
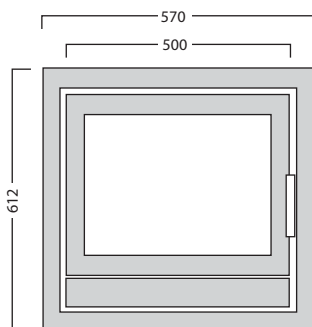

FARO 600 EA

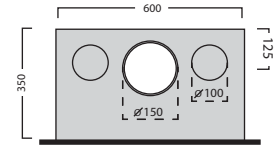
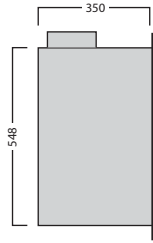
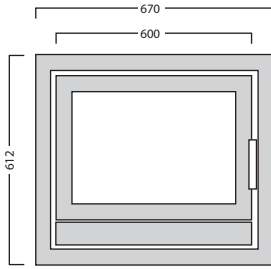

FARO 600 DF EA

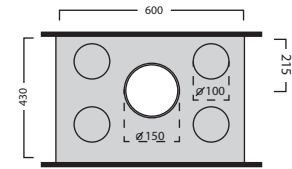
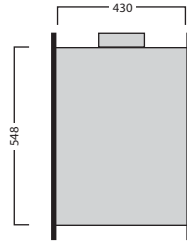
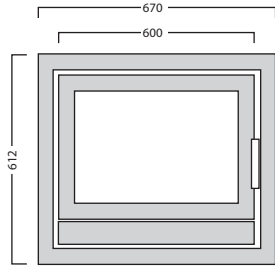

FARO 700 EA

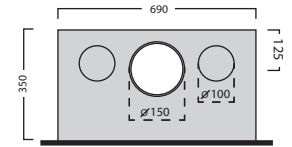
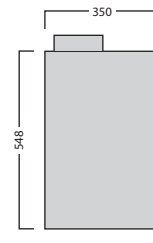
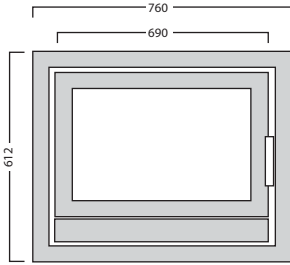

FARO 800 EA

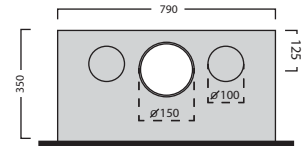
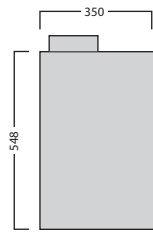
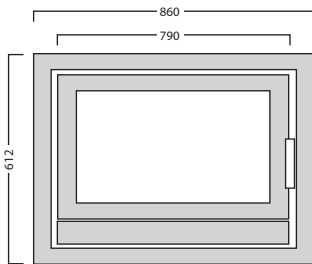

FARO 900 EA

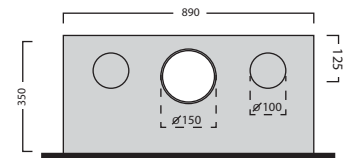
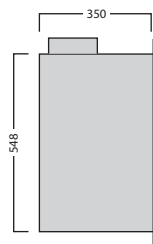
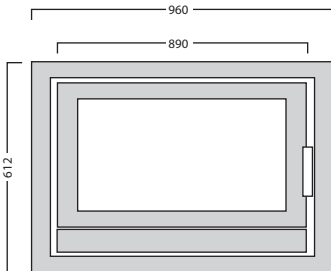

FARO 900 DF EA

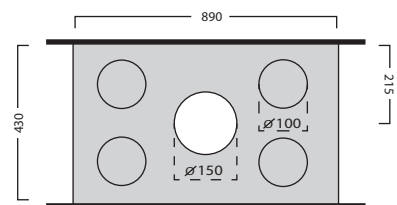
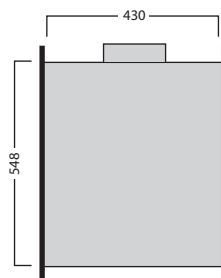
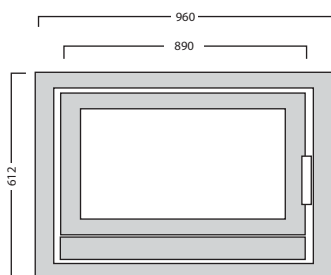

FREESTANDING STOVES TECHNICAL INFORMATION

POÊLES INFORMATION TECHNIQUE

LISBOA SL 700

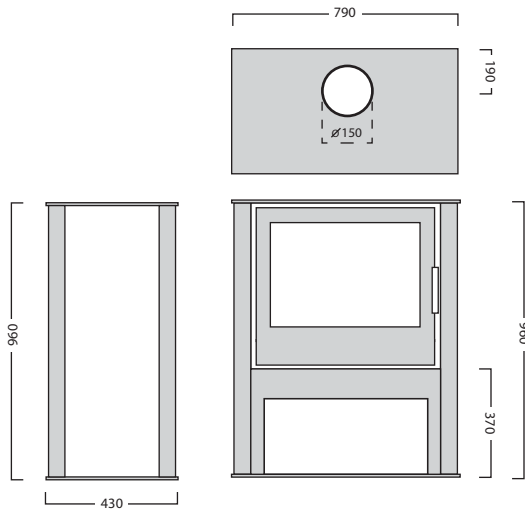

LISBOA SL 800

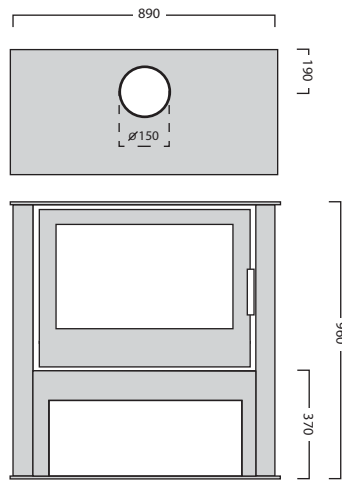

LISBOA SL 900

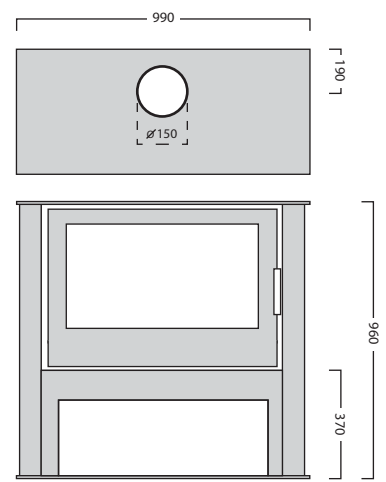

FARO SL 500

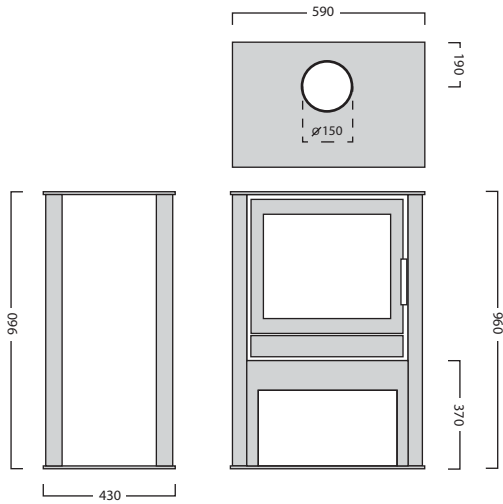

FARO SL 600

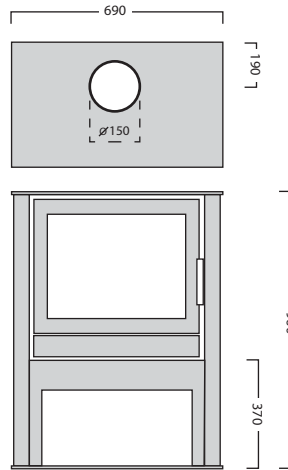

FARO SL 700

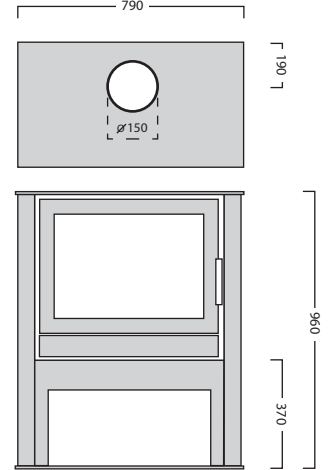

FARO SL 800

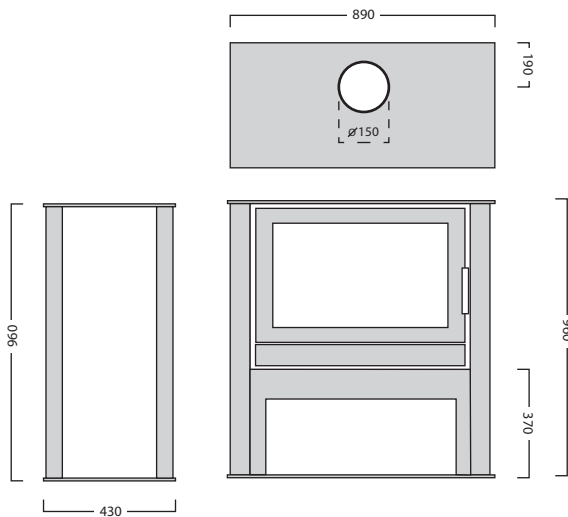

FARO SL 900

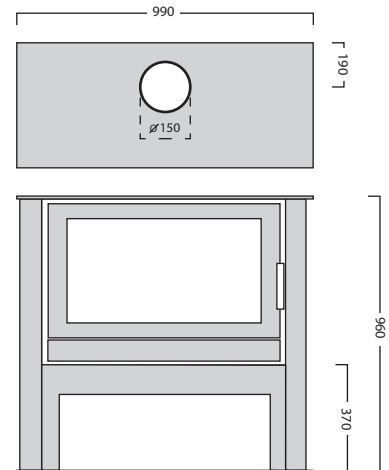



OPTIONS
OPTIONNELS



SQUARE FRAME SM
CADRE SM



FRAME SMV GLASS
CADRE SMV VERRE

MEASURES OF FRAMES
MESURES DE CADRES

SM 500 - 570 x 625 x 40 mm
SM 600 - 670 x 625 x 40 mm
SM 700 - 760 x 625 x 40 mm
SM 800 - 860 x 625 x 40 mm
SM 900 - 960 x 625 x 40 mm

AVAILABLE FOR ALL STOVES MODELS
DISPONIBLE POUR TOUS LES MODÈLES DE FOYEURS

Via Central de Milheirós, 380
4475-330 Maia
Tel. 229 600 330 Tlm. 939 600 330
Fax. 229 600 329
E-mail: geral@termofoc.com

GPS: 41.223946, -8.5846222



www.termofoc.com